

TLC6C5912 12-Channel Shift-Register LED Driver

1 Features

- Wide V_{CC} Range From 3 V to 5.5 V
- Output Maximum Rating of 40 V
- Twelve Power DMOS Transistor Outputs of 50-mA Continuous Current With $V_{CC} = 5$ V or 200-mA PWM Current With Single-Pulse Duration Less Than 1 ms and Average Current Less Than 50 mA_r
- Thermal Shutdown Protection
- Enhanced Cascading for Multiple Stages
- All Registers Cleared With Single Input
- Low Power Consumption
- Slow Switching Time (t_r and t_f), Which Helps Significantly With Reducing EMI
- 20-Pin TSSOP-PW Package

2 Applications

- Appliance Display Panel
- Elevator Display Panel
- PLC Function Indicator
- Seven-Segment Display

3 Description

The TLC6C5912 is a monolithic, medium-voltage, low-current power 12-bit shift register designed for use in systems that require relatively moderate load power, such as LEDs.

This device contains a 12-bit serial-in, parallel-out shift register that feeds a 12-bit D-type storage register. Data transfers through both the shift and storage registers on the rising edge of the shift-register clock (SRCK) and the register clock (RCK), respectively. The storage register transfers data to the output buffer when shift register clear (\overline{CLR}) is high. A low on \overline{CLR} clears all registers in the device. Holding the output enable (\overline{G}) high holds all data in the output buffers low, and all drain outputs are off. Holding \overline{G} low makes data from the storage register transparent to the output buffers.

This device contains a 12-bit serial-in, parallel-out shift register that feeds a 12-bit D-type storage register. Separate clocks are provided for both the shift and storage registers.

Outputs are low-side, open-drain DMOS transistors with output ratings of 40 V and 50-mA continuous sink-current OR 200-mA PWM current with single-pulse duration less than 1 ms and average current less than 50 mA capabilities when $V_{CC} = 5$ V. The device contains built-in thermal shutdown protection and provides up to 2000 V of ESD protection when tested using the human-body model and the 200-V machine model.

The TLC6C5912 characterization is for operation over the ambient temperature range of -40°C to 105°C .

Device Information⁽¹⁾

PART NUMBER	PACKAGE	BODY SIZE (NOM)
TLC6C5912	TSSOP (20)	6.50 mm x 4.40 mm

(1) For all available packages, see the orderable addendum at the end of the data sheet.

Typical Application Schematic

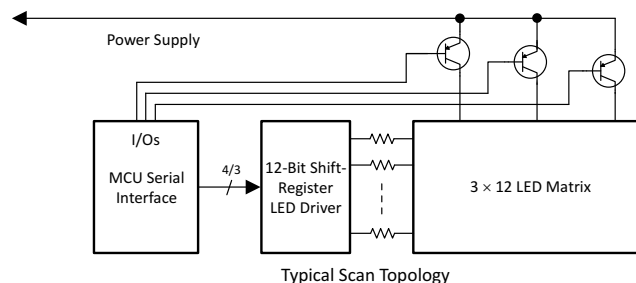
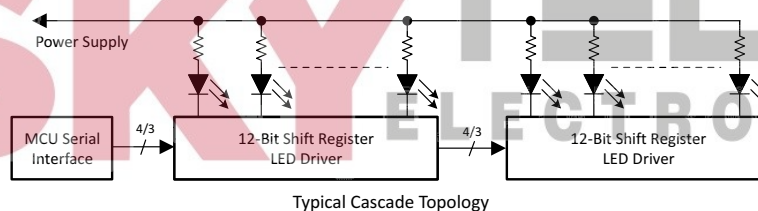

Copyright © 2016, Texas Instruments Incorporated



An IMPORTANT NOTICE at the end of this data sheet addresses availability, warranty, changes, use in safety-critical applications, intellectual property matters and other important disclaimers. PRODUCTION DATA

Table of Contents

1 Features	1	8.2 Functional Block Diagram	10
2 Applications	1	8.3 Feature Description	10
3 Description	1	8.4 Device Functional Modes	11
4 Revision History	2	9 Application and Implementation	12
5 Pin Configuration and Functions	3	9.1 Application Information	12
6 Specifications	4	9.2 Typical Application	12
6.1 Absolute Maximum Ratings	4	10 Power Supply Recommendations	15
6.2 ESD Ratings	4	11 Layout	15
6.3 Recommended Operating Conditions	4	11.1 Layout Guidelines	15
6.4 Thermal Information	5	11.2 Layout Example	15
6.5 Electrical Characteristics	5	12 Device and Documentation Support	16
6.6 Switching Characteristics	5	12.1 Community Resources	16
6.7 Typical Characteristics	7	12.2 Trademarks	16
7 Parameter Measurement Information	9	12.3 Electrostatic Discharge Caution	16
8 Detailed Description	10	12.4 Glossary	16
8.1 Overview	10	13 Mechanical, Packaging, and Orderable Information	16

4 Revision History

NOTE: Page numbers for previous revisions may differ from page numbers in the current version.

DATE	REVISION	NOTE
May 2016	*	Initial release



5 Pin Configuration and Functions

PW Package
20-Pin TSSOP
Top View

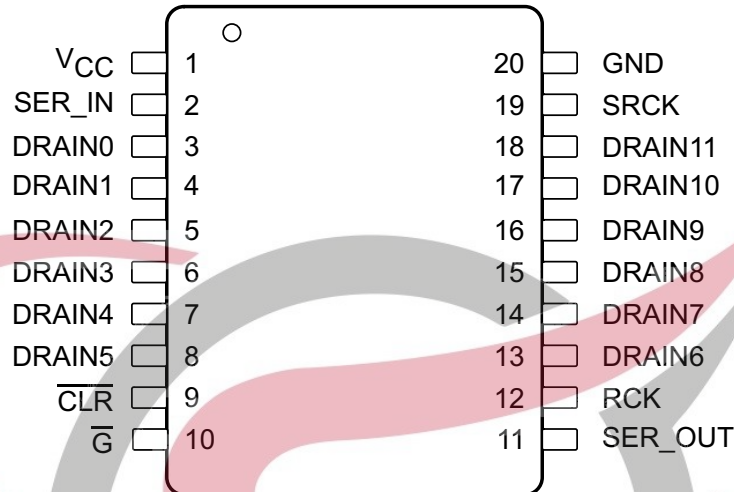

Pin Functions

PIN		I/O	DESCRIPTION
NAME	NO.		
$\overline{\text{CLR}}$	9	I	Shift register clear, active-low: $\overline{\text{CLR}}$ is the signal used to clear all the registers. The storage register transfers data to the output buffer when shift register clear CLR is high. Driving CLR is low clears all the registers in the device.
DRAIN0	3	O	Open-drain output: DRAIN0 to DRAIN11 are the LED current-sink channels. These pins connect to the LED cathodes, and they can survive up to 40-V LED supply voltage.
DRAIN1	4	O	
DRAIN2	5	O	
DRAIN3	6	O	
DRAIN4	7	O	
DRAIN5	8	O	
DRAIN6	13	O	
DRAIN7	14	O	
DRAIN8	15	O	
DRAIN9	16	O	
DRAIN10	17	O	
DRAIN11	18	O	
$\overline{\text{G}}$	10	I	Output enable, active-low: $\overline{\text{G}}$ is the LED channel enable and disable input pin. Having $\overline{\text{G}}$ low enables all drain channels according to the output-latch register content. When high, all channels are off.
GND	20	—	Power ground: GND is the ground reference pin for the device. This pin must connect to the ground plane on the PCB.
RCK	12	I	Register clock: RCK is the storage register clock. The data in each shift register stage transfers to the storage register at the rising edge of RCK. Data in the storage register appears at the output whenever the output enable $\overline{\text{G}}$ input signal is high.
SER IN	2	I	Serial-data input: SER IN is the serial data input. Data on SER IN loads into the internal register on each rising edge of SRCK.

Pin Functions (continued)

PIN		I/O	DESCRIPTION
NAME	NO.		
SER OUT	11	O	Serial-data output: SER OUT is the serial data output of the 12-bit serial shift register. The purpose of this pin is to cascade several devices on the serial bus. By connecting the SER OUT pin to the SER IN input of the next device on the serial bus to cascade, the data transfers to the next device on the falling edge of SRCK. This can improve the cascade application reliability, as it can avoid the issue that the second device receives SRCK and data input at the same rising edge of SRCK.
SRCK	19	I	Shift-register clock: SRCK is the serial clock input. On each rising SRCK edge, data transfers from SER IN to the internal serial shift registers.
V _{CC}	1	I	Power supply: V _{CC} is the power supply pin voltage for the device. TI recommends adding a 0.1 μF ceramic capacitor close to the pin.

6 Specifications

6.1 Absolute Maximum Ratings

over operating free-air temperature range (unless otherwise noted)⁽¹⁾

	MIN	MAX	UNIT
V _{CC} Logic supply voltage		8	V
V _I Logic input-voltage	-0.3	8	V
V _{DS} Power DMOS drain-to-source voltage		42	V
Continuous total dissipation	See Thermal Information		
Operating ambient temperature (Top)		105	°C
T _J Operating junction temperature	-40	125	°C
T _{stg} Storage temperature	-55	165	°C

(1) Stresses beyond those listed under *Absolute Maximum Ratings* may cause permanent damage to the device. These are stress ratings only, which do not imply functional operation of the device at these or any other conditions beyond those indicated under *Recommended Operating Conditions*. Exposure to absolute-maximum-rated conditions for extended periods may affect device reliability.

6.2 ESD Ratings

	VALUE	UNIT
V _(ESD) Electrostatic discharge	Human-body model (HBM), per ANSI/ESDA/JEDEC JS-001 ⁽¹⁾	±2000
	Charged-device model (CDM), per JEDEC specification JESD22-C101 ⁽²⁾	±750

(1) JEDEC document JEP155 states that 500-V HBM allows safe manufacturing with a standard ESD control process.

(2) JEDEC document JEP157 states that 250-V CDM allows safe manufacturing with a standard ESD control process.

6.3 Recommended Operating Conditions

	MIN	MAX	UNIT
V _{CC} Supply voltage	3	5.5	V
V _{IH} High-level input voltage	2.4		V
V _{IL} Low-level input voltage		0.7	V
t _{su} Setup time, SER IN high before SRCK↑	15		ns
t _h Hold time, SER IN high after SRCK↑	15		ns
t _w Pulse duration	40		ns
T _A Operating ambient temperature	-40	105	°C

6.4 Thermal Information

THERMAL METRIC ⁽¹⁾		TLC6C5912	UNIT
		PW (TSSOP)	
		20 PINS	
R _{θJA}	Junction-to-ambient thermal resistance	114.8	°C/W
R _{θJC(top)}	Junction-to-case (top) thermal resistance	44.1	°C/W
R _{θJB}	Junction-to-board thermal resistance	61.3	°C/W
ψ _{JT}	Junction-to-top characterization parameter	4.7	°C/W
ψ _{JB}	Junction-to-board characterization parameter	60.8	°C/W

(1) For more information about traditional and new thermal metrics, see the *Semiconductor and IC Package Thermal Metrics* application report, [SPRA953](#).

6.5 Electrical Characteristics

V_{CC} = 5 V, T_A = 25°C (unless otherwise noted)

PARAMETER	TEST CONDITIONS	MIN	TYP	MAX	UNIT	
	DRAIN0 to DRAIN11, drain-to-source voltage			40	V	
V _{OH}	High-level output voltage, SER OUT I _{OH} = -20 μA I _{OH} = -4 mA	V _{CC} = 5 V	4.9	4.99	V	
			4.5	4.69		
V _{OL}	Low-level output voltage, SER OUT I _{OH} = 20 μA I _{OH} = 4 mA	V _{CC} = 5 V	0.001	0.01	V	
			0.25	0.4		
I _{IH}	High-level input current V _{CC} = 5 V, V _I = V _{CC}		0.2		μA	
I _{IL}	Low-level input current V _{CC} = 5 V, V _I = 0		-0.2		μA	
I _{CC}	Logic supply current V _{CC} = 5 V, No clock signal	All outputs off	0.1	1	μA	
		All outputs on	130	170		
I _{CC(FRQ)}	Logic supply current at frequency f _{SRCK} = 5 MHz, C _L = 30 pF, all outputs on		300		μA	
I _{DSX}	Off-state drain current V _{DS} = 30 V, V _{CC} = 5 V V _{DS} = 30 V, T _C = 125°C, V _{CC} = 5 V			0.1	μA	
				0.15		0.3
r _{DS(on)}	Static drain-source on-state resistance	I _D = 20 mA, V _{CC} = 5 V, T _A = 25°C, single channel ON	6	7.4	8.6	Ω
		I _D = 20 mA, V _{CC} = 5 V, T _A = 25°C, all channels ON	6.7	8.9	9.6	
		I _D = 20 mA, V _{CC} = 3.3 V, T _A = 25°C, single channel ON	7.9	9.3	11.2	
		I _D = 20 mA, V _{CC} = 3.3 V, T _A = 25°C, all channels ON	8.7	10.6	12.3	
		I _D = 20 mA, V _{CC} = 5 V, T _A = 105°C, single channel ON	9.1	11.2	12.9	
		I _D = 20 mA, V _{CC} = 5 V, T _A = 105°C, all channels ON	10.3	13	14.5	
		I _D = 20 mA, V _{CC} = 3.3 V, T _A = 105°C, single channel ON	11.6	13.7	16.4	
		I _D = 20 mA, V _{CC} = 3.3 V, T _A = 105°C, all channels ON	12.8	15.6	18.2	
T _{SHUTDOWN}	Thermal shutdown trip point	150	175	200	°C	
t _{HYS}	Hysteresis		15		°C	

6.6 Switching Characteristics

V_{CC} = 5 V, T_A = 25°C

PARAMETER	TEST CONDITIONS	MIN	TYP	MAX	UNIT
t _{PLH}	Propagation delay time, low-to-high-level output from \overline{G}		210		ns
t _{PHL}	Propagation delay time, high-to-low-level output from \overline{G}		75		ns
t _r	Rise time, drain output		250		ns
t _f	Fall time, drain output		200		ns
t _{pd}	Propagation delay time, SRCK↓ to SEROUT	C _L = 30 pF, I _D = 48 mA	35		ns
t _{or}	SEROUT rise time (10% to 90%)	C _L = 30 pF	20		ns
t _{of}	SEROUT fall time (90% to 10%)	C _L = 30 pF	20		ns

Switching Characteristics (continued)

$V_{CC} = 5\text{ V}$, $T_A = 25^\circ\text{C}$

PARAMETER		TEST CONDITIONS	MIN	TYP	MAX	UNIT
$f_{(SRCK)}$	Serial clock frequency	$C_L = 30\text{ pF}$, $I_D = 20\text{ mA}$			10	MHz
t_{SRCK_WH}	SRCK pulse duration, high		30			ns
t_{SRCK_WL}	SRCK pulse duration, low		30			ns

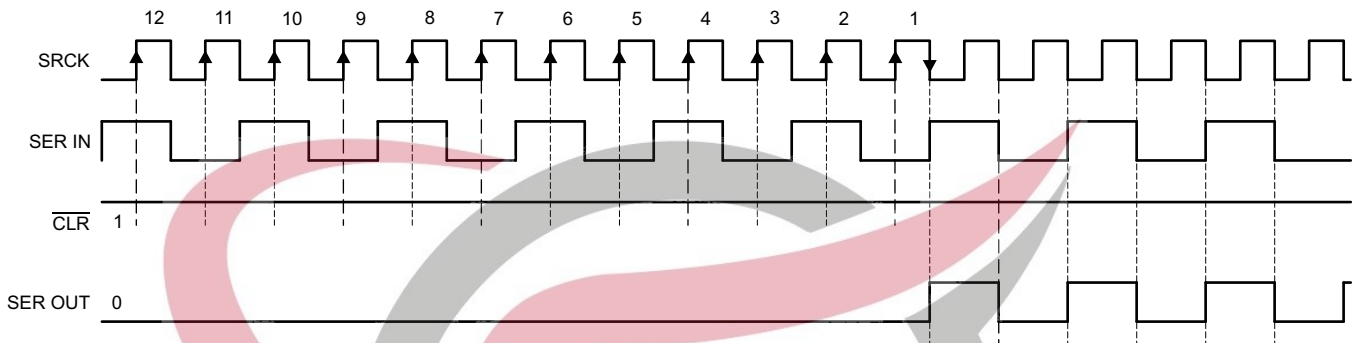

Figure 1. SER IN to SER OUT Waveform

Figure 1 shows the SER IN to SER OUT waveform. The output signal appears on the falling edge of the shift register clock (SRCK) because there is a phase inverter at SER OUT (see Figure 2). As a result, it takes seven and a half periods of SRCK for data to transfer from SER IN to SER OUT.

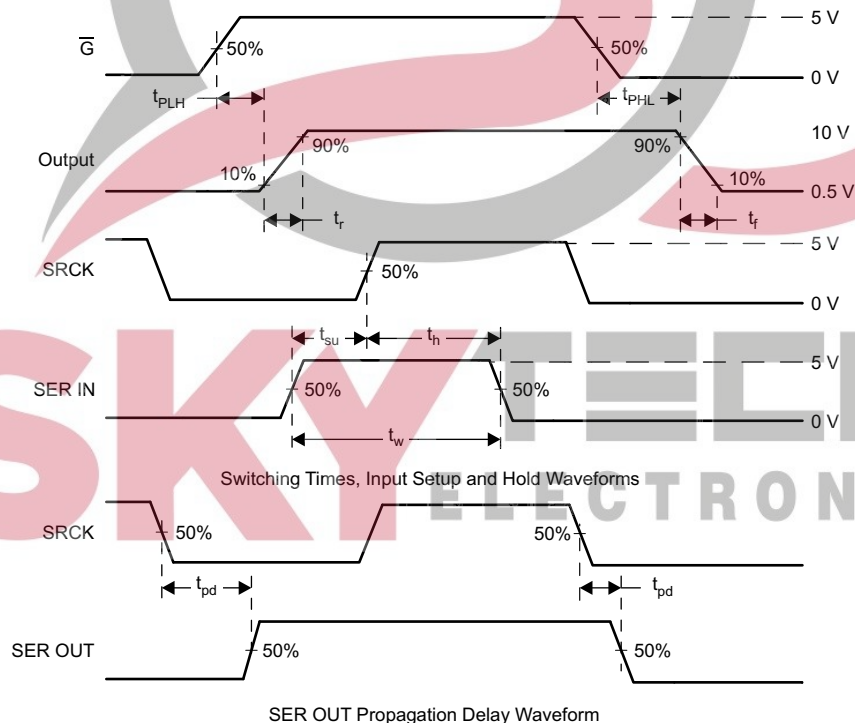
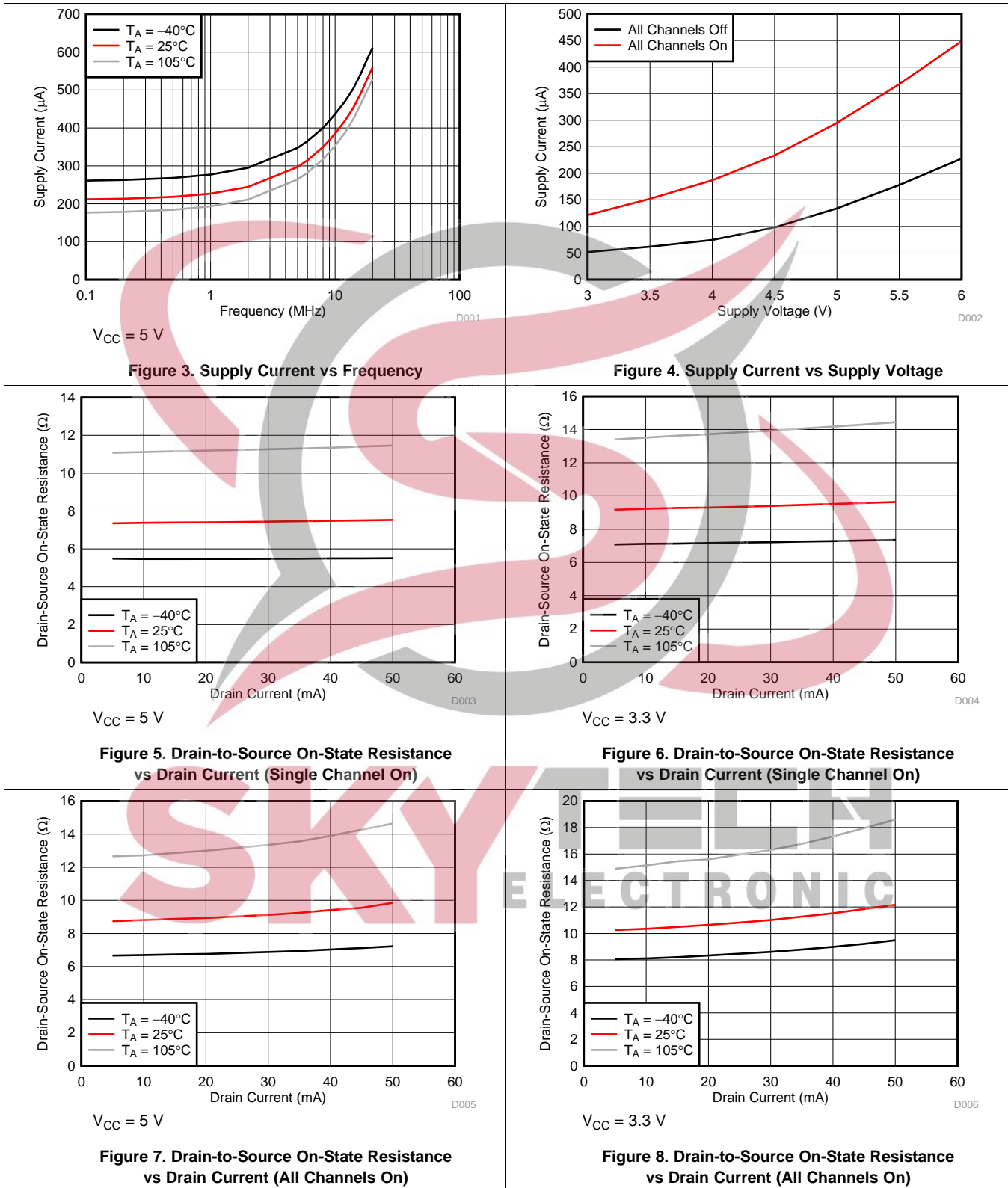

Figure 2. Switching Times and Voltage Waveforms

Figure 2 shows the switching times and voltage waveforms. Tests for all these parameters took place using the test circuit shown in Figure 12.

6.7 Typical Characteristics

Conditions for Figure 5 and Figure 6: Single channel on; conditions for Figure 7, Figure 8, and Figure 9: All channels on.



Typical Characteristics (continued)

Conditions for Figure 5 and Figure 6: Single channel on; conditions for Figure 7, Figure 8, and Figure 9: All channels on.

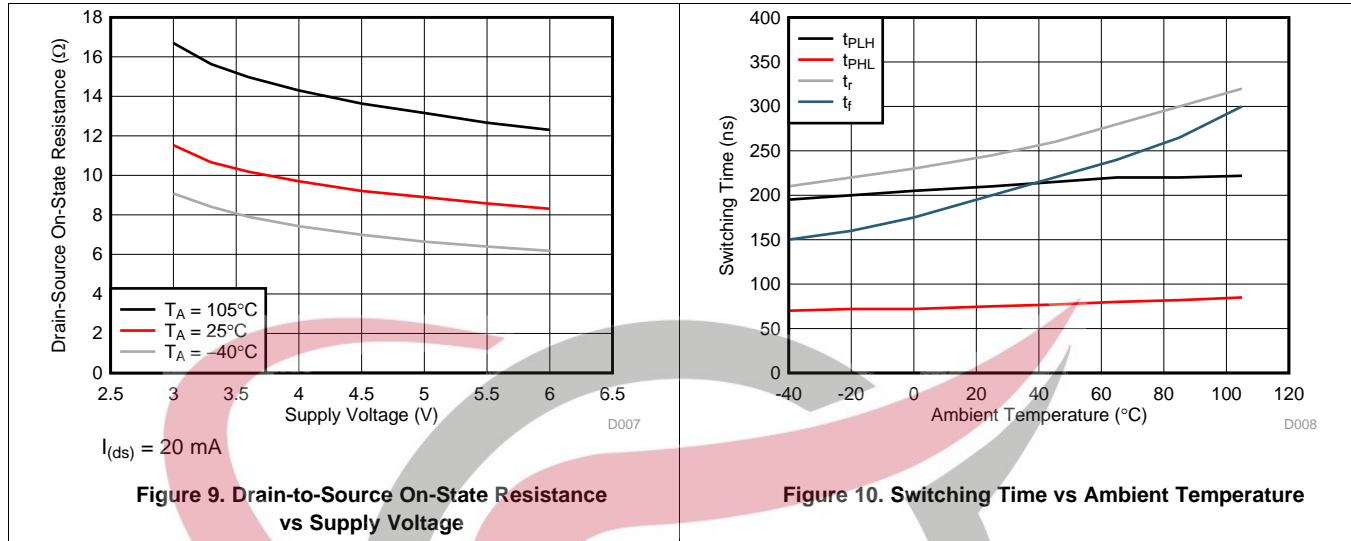

7 Parameter Measurement Information

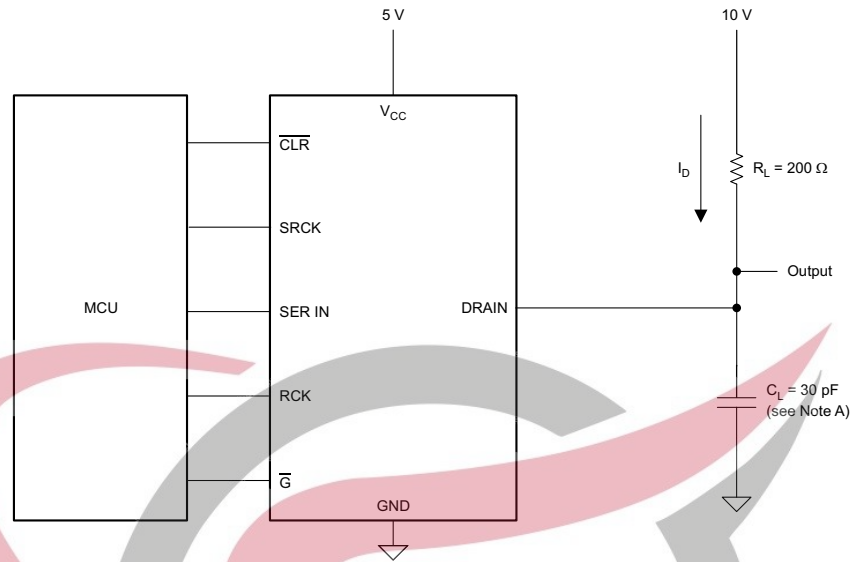

Copyright © 2016, Texas Instruments Incorporated

A. C_L includes probe and jig capacitance.

Figure 11. Resistive-Load Test Circuit

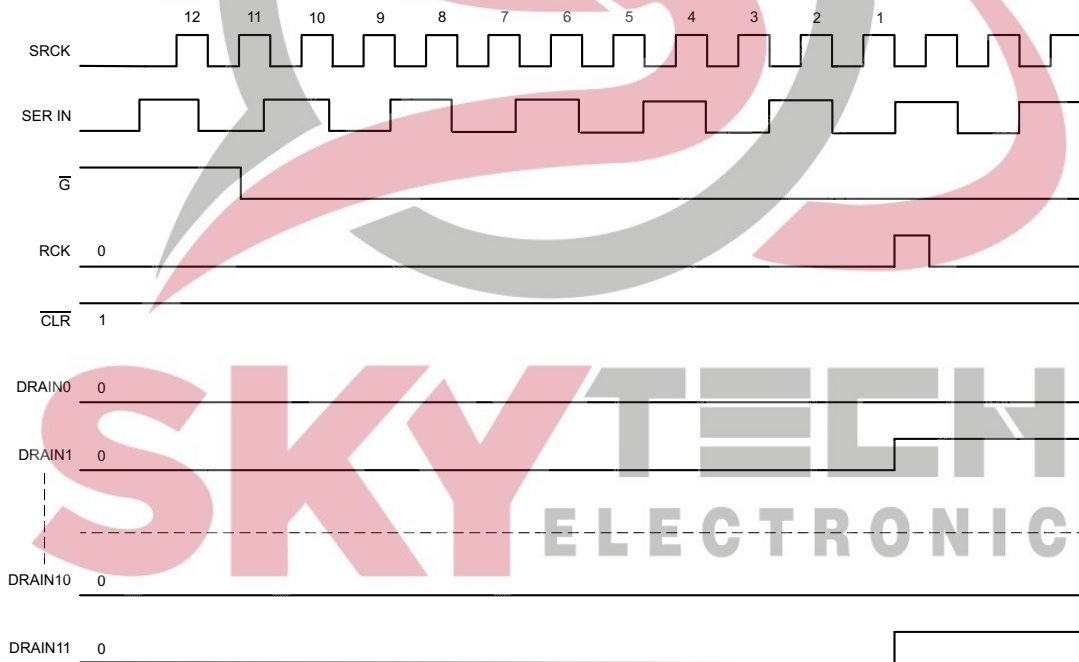

Figure 12. Voltage Waveforms

Figure 11 and Figure 12 show the resistive-load test circuit and voltage waveforms. One can see from Figure 12 that with G held low and CLR held high, the status of each drain changes on the rising edge of the register clock, indicating the transfer of data to the output buffers at that time.

8 Detailed Description

8.1 Overview

The TLC6C5912 device is a monolithic, medium-voltage, low current 12-bit shift register designed to drive relatively moderate load power such LEDs. The device contains a 12-bit serial-in, parallel-out shift register that feeds a 12-bit D-type storage register. Thermal shutdown protection is also built-into the device.

8.2 Functional Block Diagram

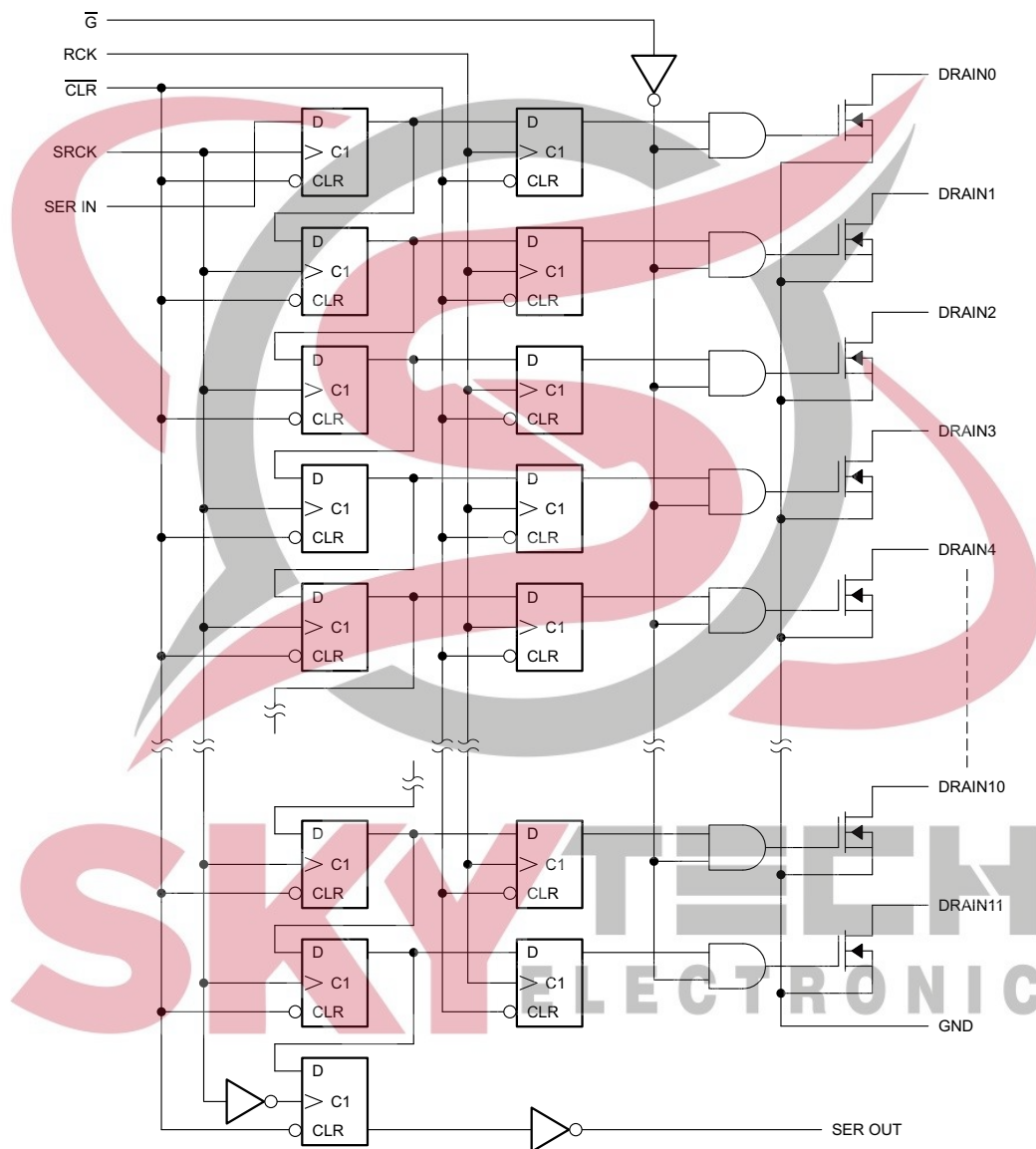

8.3 Feature Description

8.3.1 Thermal Shutdown

The device implements an internal thermal shutdown to protect itself if the junction temperature exceeds 175°C (typical). The thermal shutdown forces the device to have an open state when the junction temperature exceeds the thermal trip threshold. Once the junction temperature decreases to less than 160°C (typical), the device begins to operate again.

Feature Description (continued)

8.3.2 Serial-In Interface

The TLC6C598 device contains an 8-bit serial-in, parallel out shift register that feeds an 8-bit D-type storage register. Data transfer through both the shift and storage registers on the rising edge of the shift register clock (SRCK) and the register clock (RCK), respectively. The storage transfers data to the output buffer when shift register clear (CLR) is high.

8.3.3 Clear Register

A logic low on $\overline{\text{CLR}}$ clears all registers in the device. TI suggests clearing the device during power up or initialization.

8.3.4 Cascade Through SER OUT

By connecting the SER OUT pin to the SER IN input of the next device on the serial bus to cascade, the data transfers to the next device on the falling edge of SRCK. This can improve the cascade application reliability, as it can avoid that the second device receives SRCK and data input at the same rising edge of SRCK.

8.3.5 Output Control

Holding the output enable (G) high holds all data in the output buffers low, and all drain outputs are off. Holding G low makes data from the storage register transparent to the output buffers. When data in the output buffers is low, the DMOS transistor outputs are off. When data is high, the DMOS transistor outputs are capable of sink-current. This pin also be used for global PWM dimming.

8.4 Device Functional Modes

8.4.1 Operation With $V_{CC} < 3\text{ V}$

This device works normally during $3\text{ V} \leq V_{CC} \leq 5.5\text{ V}$, when operation voltage is lower than 3 V. The behavior of device cannot be ensured, including communication interface and current capability.

8.4.2 Operation With $5.5\text{ V} \leq V_{CC} \leq 8\text{ V}$

The device works normally during this voltage range, but reliability issues may occurs while the device works for a long time in this voltage range.



SKYTECH
ELECTRONIC

9 Application and Implementation

NOTE

Information in the following applications sections is not part of the TI component specification, and TI does not warrant its accuracy or completeness. TI's customers are responsible for determining suitability of components for their purposes. Customers should validate and test their design implementation to confirm system functionality.

9.1 Application Information

The TLC6C5912 device is a serial-in, parallel-out, power logic 8-bit shift register with low-side open-drain DMOS output rating of 40 V and 50-mA continuous sink-current capabilities when $V_{CC} = 5$ V. The device is designed to drive resistive loads and is particularly well-suited as an interface between a microcontroller and LEDs or lamps. The device also provides up to 2000 V of ESD protection when tested using the human body model and 200 V when using the machine model.

9.2 Typical Application

Figure 13 shows a typical cascade application circuit with two TLC6C5912 chips configured to cascade topology. The MCU generates all the input signals.



Typical Application (continued)

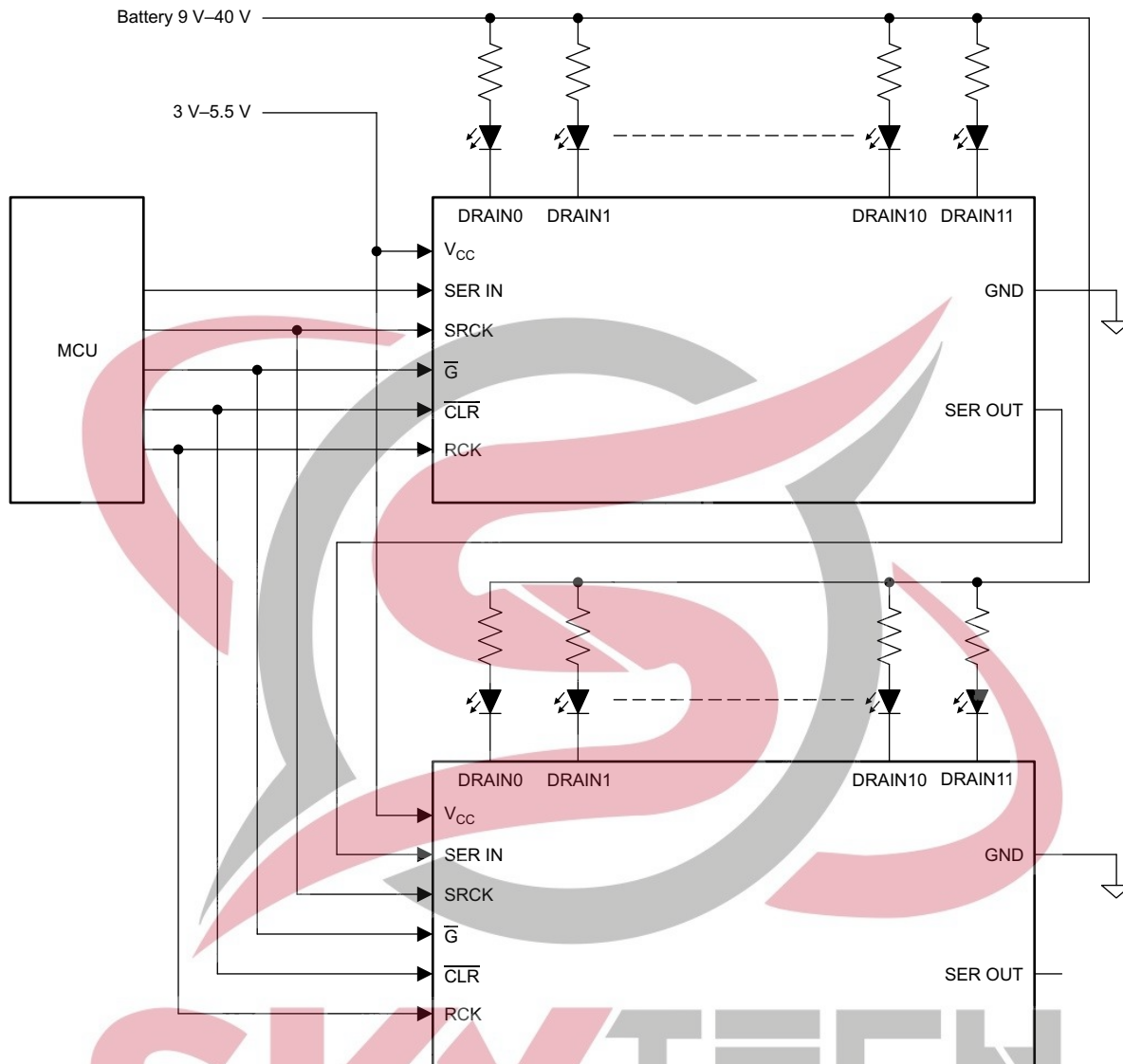

Figure 13. Typical Application Circuit

9.2.1 Design Requirements

Table 1 lists the parameters for this design example.

Table 1. Design Parameters

DESIGN PARAMETER	EXAMPLE VALUE
V _{battery}	9 V to 40 V
V _{CC – 1}	3.3 V
I(D0), I(D1), I(D2), I(D3), I(D4), I(D5), I(D6), I(D7), I(D8), I(D9), I(D10), I(D11)	30 mA
V _{CC – 2}	5 V
I(D12), I(D13), I(D14), I(D15), I(D16), I(D17), I(D18), I(D19), I(D20), I(D21), I(D122), I(D23)	50 mA

9.2.2 Detailed Design Procedure

To begin the design process, the designer must decide on a few parameters:

- V_{supply}: LED supply voltage
- V_{Dx}: LED forward voltage
- I: LED current

After determining the parameters, calculate the resistor in series with LED using [Equation 1](#).

$$R_x = (V_{\text{supply}} - V_{Dx}) / I \quad (1)$$

9.2.3 Application Curve

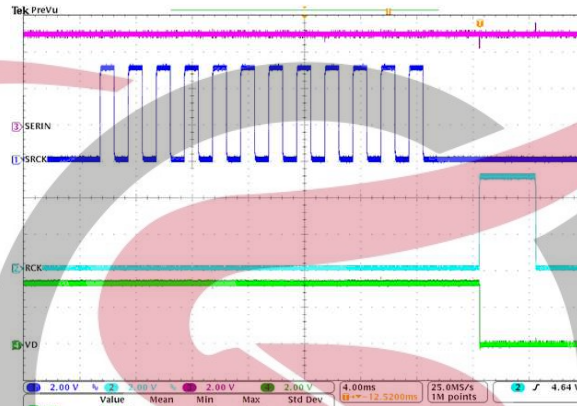

Figure 14. TLC6C5912 Application Waveform

SKYTECH
ELECTRONIC

10 Power Supply Recommendations

The TLC6C5912 device is designed to operate from an input voltage supply range from 3 V to 5.5 V. This input supply should be well regulated. TI recommends placing the ceramic bypass capacitors near the V_{CC} pin.

11 Layout

11.1 Layout Guidelines

There are no special layout requirement for the digital signal pins. The only requirement is placing the ceramic bypass capacitors near the corresponding pin.

Maximize the copper coverage on the PCB to increase the thermal conductivity of the board. The major heat-flow path from the package to the ambient is through the cooper on the PCB. Maximizing the copper coverage is extremely important when the design does not include heat sinks attached to the PCB on the other side of the package.

- Add as many thermal vias as possible directly under the package ground pad to optimize the thermal conductivity of the board.
- All thermal vias should be either plated shut or plugged and capped on both sides of the board to prevent solder voids. To ensure reliability and performance, the solder coverage should be at least 85%.

11.2 Layout Example

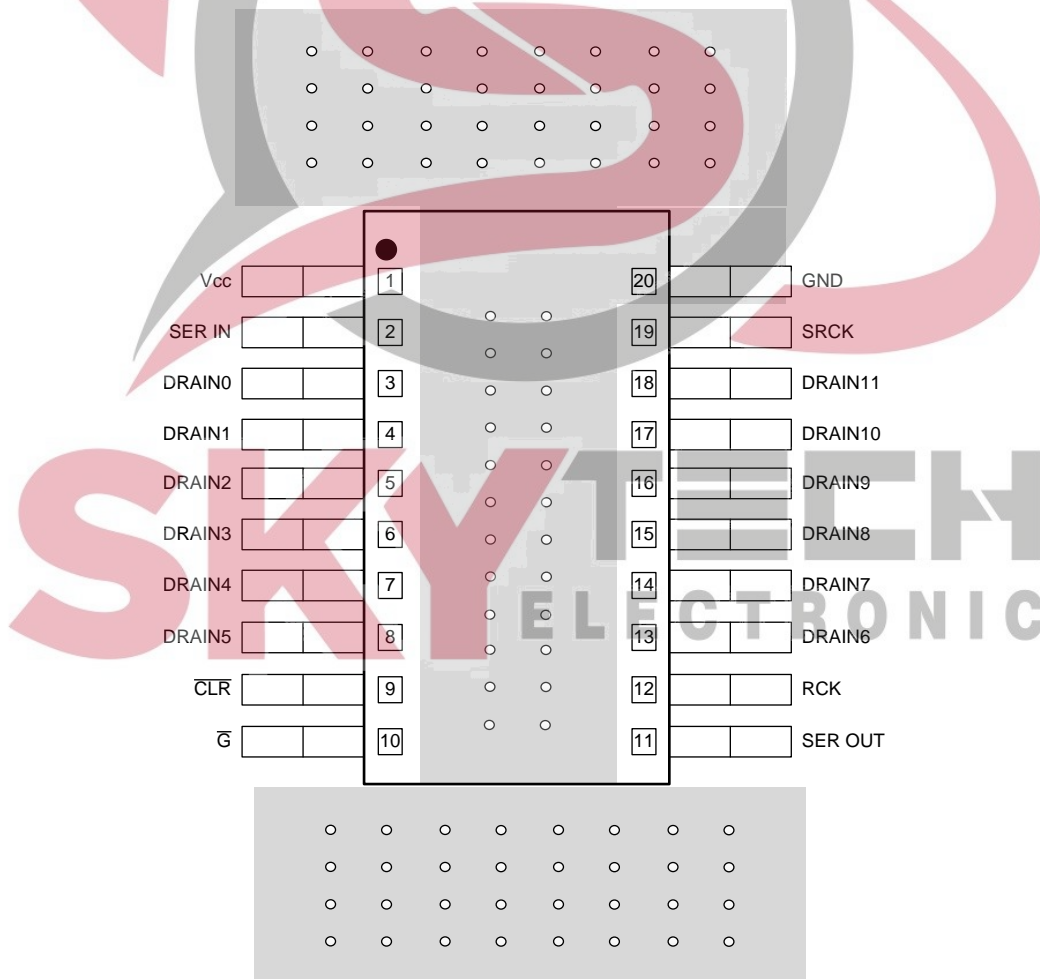

Figure 15. Layout Recommendation

12 Device and Documentation Support

12.1 Community Resources

The following links connect to TI community resources. Linked contents are provided "AS IS" by the respective contributors. They do not constitute TI specifications and do not necessarily reflect TI's views; see TI's [Terms of Use](#).

TI E2E™ Online Community *TI's Engineer-to-Engineer (E2E) Community*. Created to foster collaboration among engineers. At e2e.ti.com, you can ask questions, share knowledge, explore ideas and help solve problems with fellow engineers.

Design Support *TI's Design Support* Quickly find helpful E2E forums along with design support tools and contact information for technical support.

12.2 Trademarks

E2E is a trademark of Texas Instruments.
All other trademarks are the property of their respective owners.

12.3 Electrostatic Discharge Caution



These devices have limited built-in ESD protection. The leads should be shorted together or the device placed in conductive foam during storage or handling to prevent electrostatic damage to the MOS gates.

12.4 Glossary

[SLYZ022](#) — *TI Glossary*.

This glossary lists and explains terms, acronyms, and definitions.

13 Mechanical, Packaging, and Orderable Information

The following pages include mechanical, packaging, and orderable information. This information is the most-current data available for the designated device. This data is subject to change without notice and without revision of this document. For browser-based versions of this data sheet, see the left-hand navigation pane.



SKYTECH
ELECTRONIC

PACKAGING INFORMATION

Orderable Device	Status (1)	Package Type	Package Drawing	Pins	Package Qty	Eco Plan (2)	Lead/Ball Finish (6)	MSL Peak Temp (3)	Op Temp (°C)	Device Marking (4/5)	Samples
TLC6C5912PWR	ACTIVE	TSSOP	PW	20	2000	Green (RoHS & no Sb/Br)	NIPDAU	Level-3-260C-168 HR	-40 to 105	6C5912I	Samples

(1) The marketing status values are defined as follows:

ACTIVE: Product device recommended for new designs.

LIFEBUY: TI has announced that the device will be discontinued, and a lifetime-buy period is in effect.

NRND: Not recommended for new designs. Device is in production to support existing customers, but TI does not recommend using this part in a new design.

PREVIEW: Device has been announced but is not in production. Samples may or may not be available.

OBsolete: TI has discontinued the production of the device.

(2) **RoHS:** TI defines "RoHS" to mean semiconductor products that are compliant with the current EU RoHS requirements for all 10 RoHS substances, including the requirement that RoHS substance do not exceed 0.1% by weight in homogeneous materials. Where designed to be soldered at high temperatures, "RoHS" products are suitable for use in specified lead-free processes. TI may reference these types of products as "Pb-Free".

RoHS Exempt: TI defines "RoHS Exempt" to mean products that contain lead but are compliant with EU RoHS pursuant to a specific EU RoHS exemption.

Green: TI defines "Green" to mean the content of Chlorine (Cl) and Bromine (Br) based flame retardants meet JS709B low halogen requirements of <=1000ppm threshold. Antimony trioxide based flame retardants must also meet the <=1000ppm threshold requirement.

(3) MSL, Peak Temp. - The Moisture Sensitivity Level rating according to the JEDEC industry standard classifications, and peak solder temperature.

(4) There may be additional marking, which relates to the logo, the lot trace code information, or the environmental category on the device.

(5) Multiple Device Markings will be inside parentheses. Only one Device Marking contained in parentheses and separated by a "~" will appear on a device. If a line is indented then it is a continuation of the previous line and the two combined represent the entire Device Marking for that device.

(6) Lead/Ball Finish - Orderable Devices may have multiple material finish options. Finish options are separated by a vertical ruled line. Lead/Ball Finish values may wrap to two lines if the finish value exceeds the maximum column width.

Important Information and Disclaimer:The information provided on this page represents TI's knowledge and belief as of the date that it is provided. TI bases its knowledge and belief on information provided by third parties, and makes no representation or warranty as to the accuracy of such information. Efforts are underway to better integrate information from third parties. TI has taken and continues to take reasonable steps to provide representative and accurate information but may not have conducted destructive testing or chemical analysis on incoming materials and chemicals. TI and TI suppliers consider certain information to be proprietary, and thus CAS numbers and other limited information may not be available for release.

In no event shall TI's liability arising out of such information exceed the total purchase price of the TI part(s) at issue in this document sold by TI to Customer on an annual basis.

OTHER QUALIFIED VERSIONS OF TLC6C5912 :

- Automotive: [TLC6C5912-Q1](#)

NOTE: Qualified Version Definitions:

- Automotive - Q100 devices qualified for high-reliability automotive applications targeting zero defects



TAPE AND REEL INFORMATION

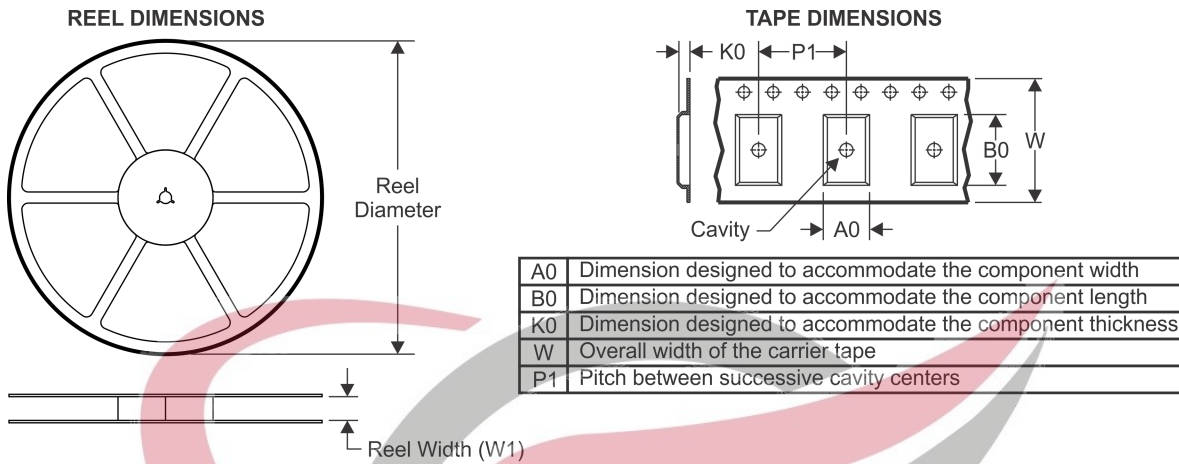

QUADRANT ASSIGNMENTS FOR PIN 1 ORIENTATION IN TAPE

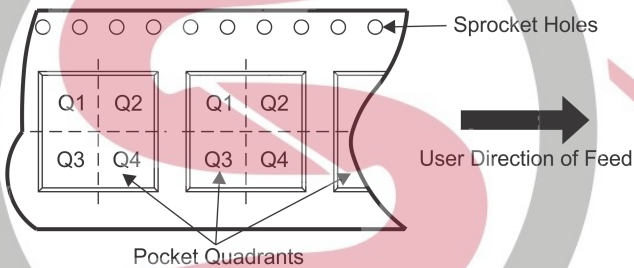

*All dimensions are nominal

Device	Package Type	Package Drawing	Pins	SPQ	Reel Diameter (mm)	Reel Width W1 (mm)	A0 (mm)	B0 (mm)	K0 (mm)	P1 (mm)	W (mm)	Pin1 Quadrant
TLC6C5912PWR	TSSOP	PW	20	2000	330.0	16.4	6.95	7.1	1.6	8.0	16.0	Q1



TAPE AND REEL BOX DIMENSIONS

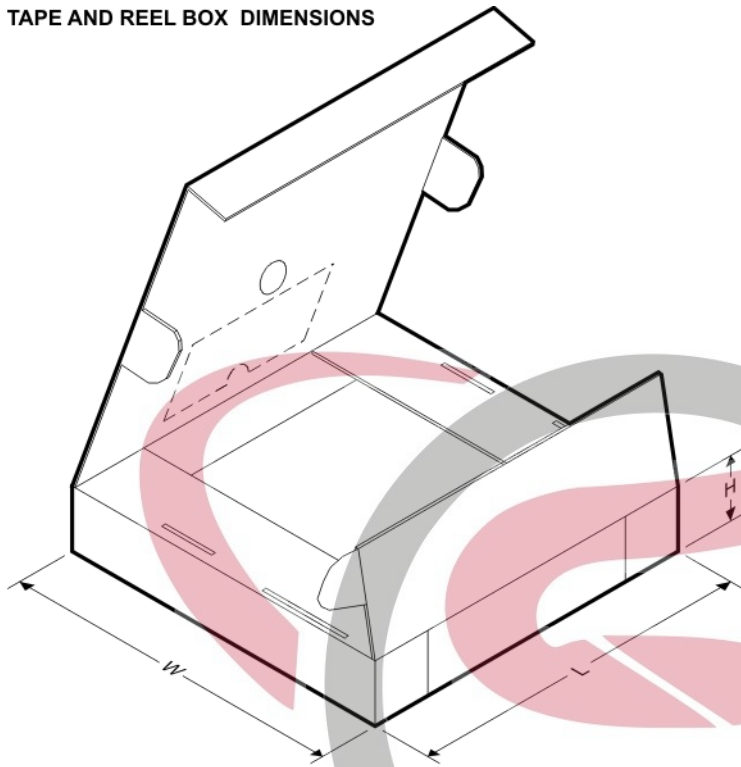

*All dimensions are nominal

Device	Package Type	Package Drawing	Pins	SPQ	Length (mm)	Width (mm)	Height (mm)
TLC6C5912PWR	TSSOP	PW	20	2000	350.0	350.0	43.0

SKYTECH
ELECTRONIC

PW (R-PDSO-G20)

PLASTIC SMALL OUTLINE

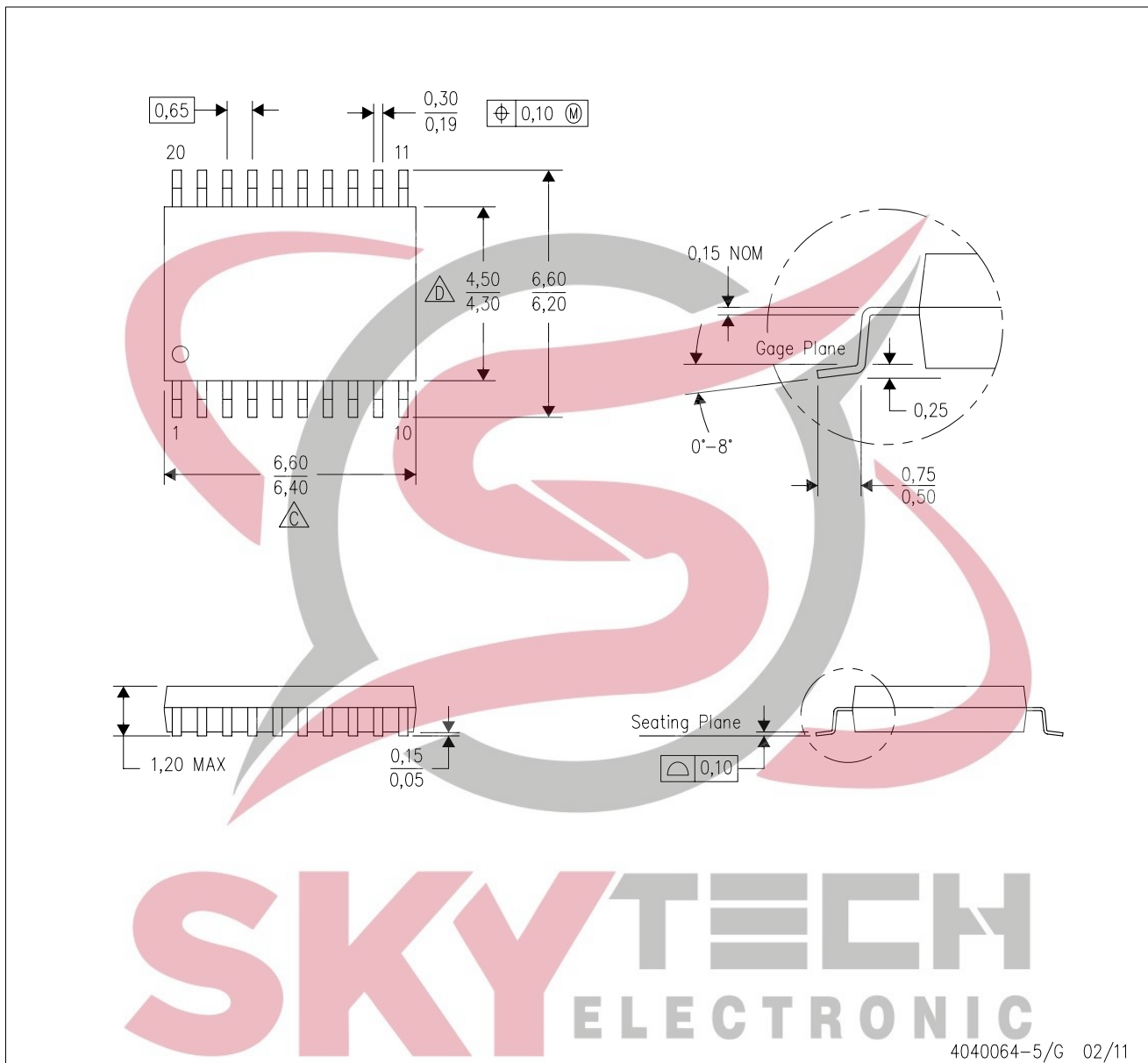

- NOTES:
- A. All linear dimensions are in millimeters. Dimensioning and tolerancing per ASME Y14.5M-1994.
 - B. This drawing is subject to change without notice.
 - C. Body length does not include mold flash, protrusions, or gate burrs. Mold flash, protrusions, or gate burrs shall not exceed 0,15 each side.
 - D. Body width does not include interlead flash. Interlead flash shall not exceed 0,25 each side.
 - E. Falls within JEDEC MO-153

PW (R-PDSO-G20)

PLASTIC SMALL OUTLINE

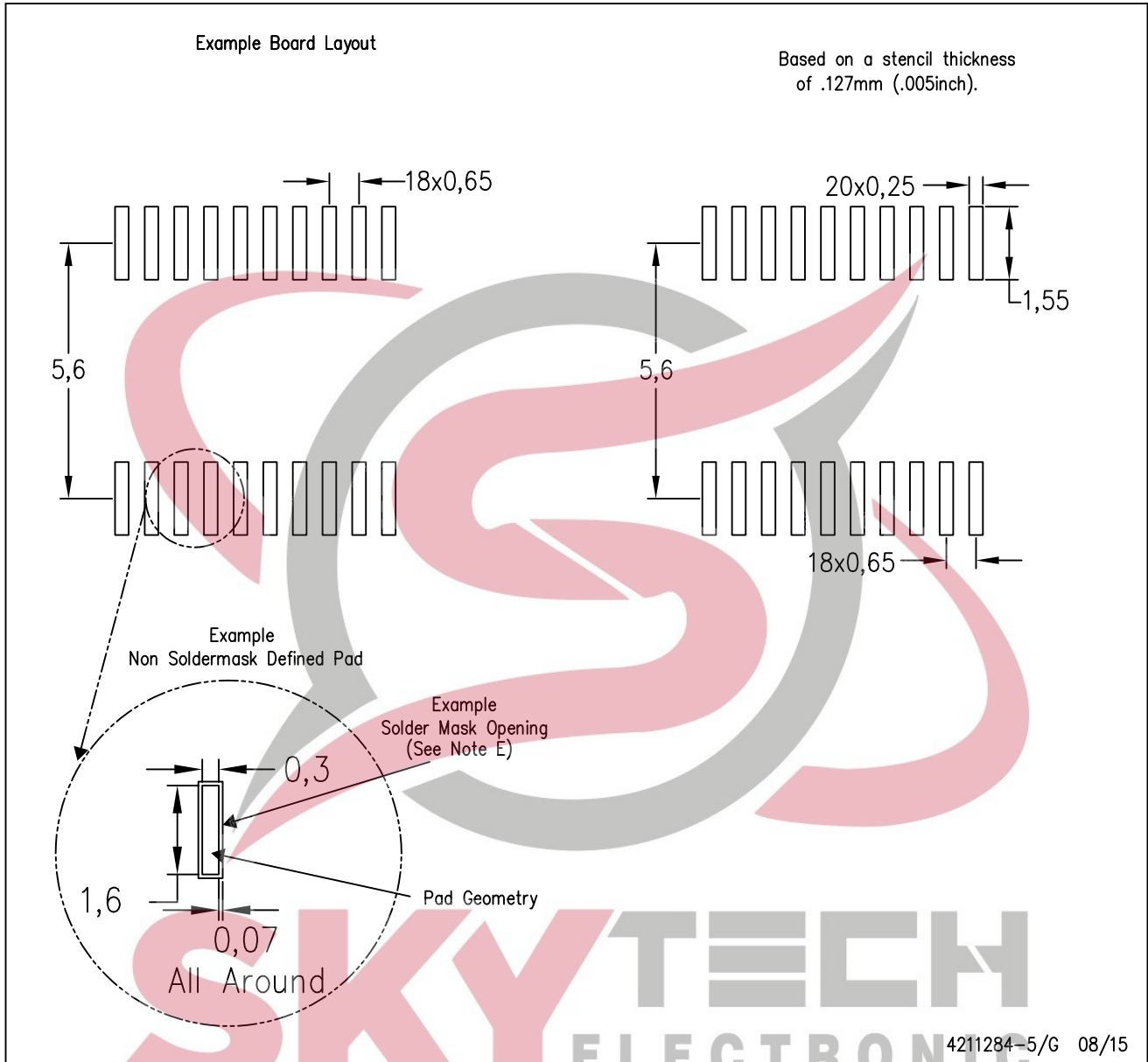

- NOTES:
- All linear dimensions are in millimeters.
 - This drawing is subject to change without notice.
 - Publication IPC-7351 is recommended for alternate design.
 - Laser cutting apertures with trapezoidal walls and also rounding corners will offer better paste release. Customers should contact their board assembly site for stencil design recommendations. Refer to IPC-7525 for other stencil recommendations.
 - Customers should contact their board fabrication site for solder mask tolerances between and around signal pads.

IMPORTANT NOTICE AND DISCLAIMER

TI PROVIDES TECHNICAL AND RELIABILITY DATA (INCLUDING DATASHEETS), DESIGN RESOURCES (INCLUDING REFERENCE DESIGNS), APPLICATION OR OTHER DESIGN ADVICE, WEB TOOLS, SAFETY INFORMATION, AND OTHER RESOURCES "AS IS" AND WITH ALL FAULTS, AND DISCLAIMS ALL WARRANTIES, EXPRESS AND IMPLIED, INCLUDING WITHOUT LIMITATION ANY IMPLIED WARRANTIES OF MERCHANTABILITY, FITNESS FOR A PARTICULAR PURPOSE OR NON-INFRINGEMENT OF THIRD PARTY INTELLECTUAL PROPERTY RIGHTS.

These resources are intended for skilled developers designing with TI products. You are solely responsible for (1) selecting the appropriate TI products for your application, (2) designing, validating and testing your application, and (3) ensuring your application meets applicable standards, and any other safety, security, or other requirements. These resources are subject to change without notice. TI grants you permission to use these resources only for development of an application that uses the TI products described in the resource. Other reproduction and display of these resources is prohibited. No license is granted to any other TI intellectual property right or to any third party intellectual property right. TI disclaims responsibility for, and you will fully indemnify TI and its representatives against, any claims, damages, costs, losses, and liabilities arising out of your use of these resources.

TI's products are provided subject to TI's Terms of Sale (www.ti.com/legal/termsofsale.html) or other applicable terms available either on ti.com or provided in conjunction with such TI products. TI's provision of these resources does not expand or otherwise alter TI's applicable warranties or warranty disclaimers for TI products.

Mailing Address: Texas Instruments, Post Office Box 655303, Dallas, Texas 75265
Copyright © 2020, Texas Instruments Incorporated

